

LH Corporation

SL016065 3-800MHZ 1:4 RF flux transformer

1:4 RF transformer **Frequency: 3-800MHZ.**

Feature:

- .1 : 4 impedance transformer.
- .SMT part.
- .Packaging 2000pcs per ree.
- .used in 50ohm systems.

ROHS COMPLIANT

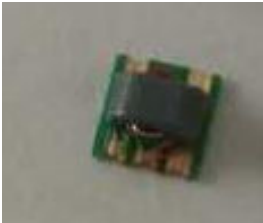

Base dimension

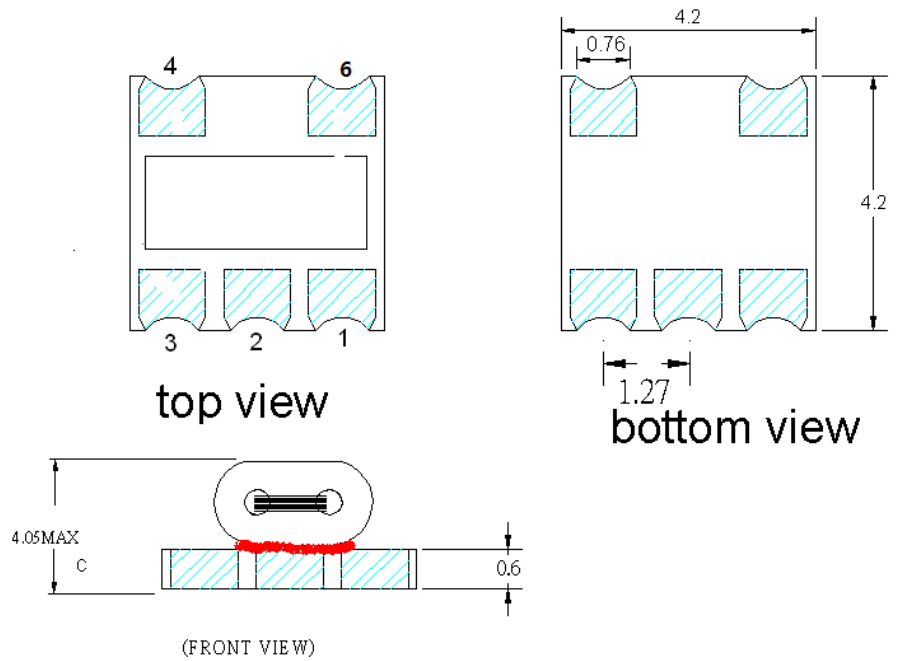

Pri

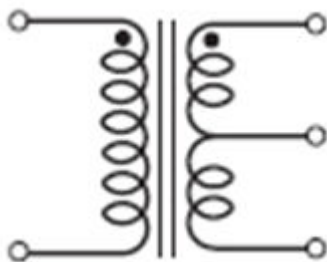

Sec

SCHEMATIC

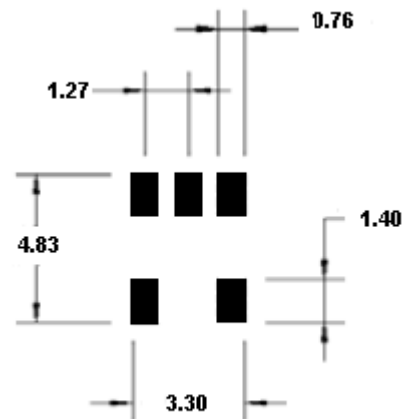

Recommended pcb configuration

LH Corporation

SL016065 3-800MHZ 1:4 RF flux transformer

Maximum Ratings

Operating Temperature	-40°C to 85°C
Storage Temperature	-55°C to 100°C
RF Power	0.25W
DC Current	30mA

Permanent damage may occur if any of these limits are exceeded.

Pin Connections

PRIMARY DOT	6
PRIMARY	4
SECONDARY DOT	1
SECONDARY	3
SECONDARY CT	2

Electrical Specifications: TA=25°C, Zo=50Ω Pin=0dbm					
Parameter	Test Conditions	Units	Min.	Typ.	Max.
Insertion Loss	3 - 10MHz	dB	----	---	3.0
	10 - 100MHz	dB	----	---	1.0
	100 - 400MHz	dB	----	---	2.0
	400 - 800MHz	dB	----	---	3.0
Amplitude Balance	3 - 800MHz	dB	----	±0.5	±1.65
Phase Balance	3 - 800MHz	Degree	----	±5	±10
Input return loss	3 - 800MHz	dB	10	13	---
RF Power Rating (max)		250mW			
DC Current Rating (max)		30mA			
Test Impedance (50Ω,75Ω, etc.)		50OHM			

LH Corporation

SL016065 3-800MHZ 1:4 RF flux transformer

Insertion Loss 6-1

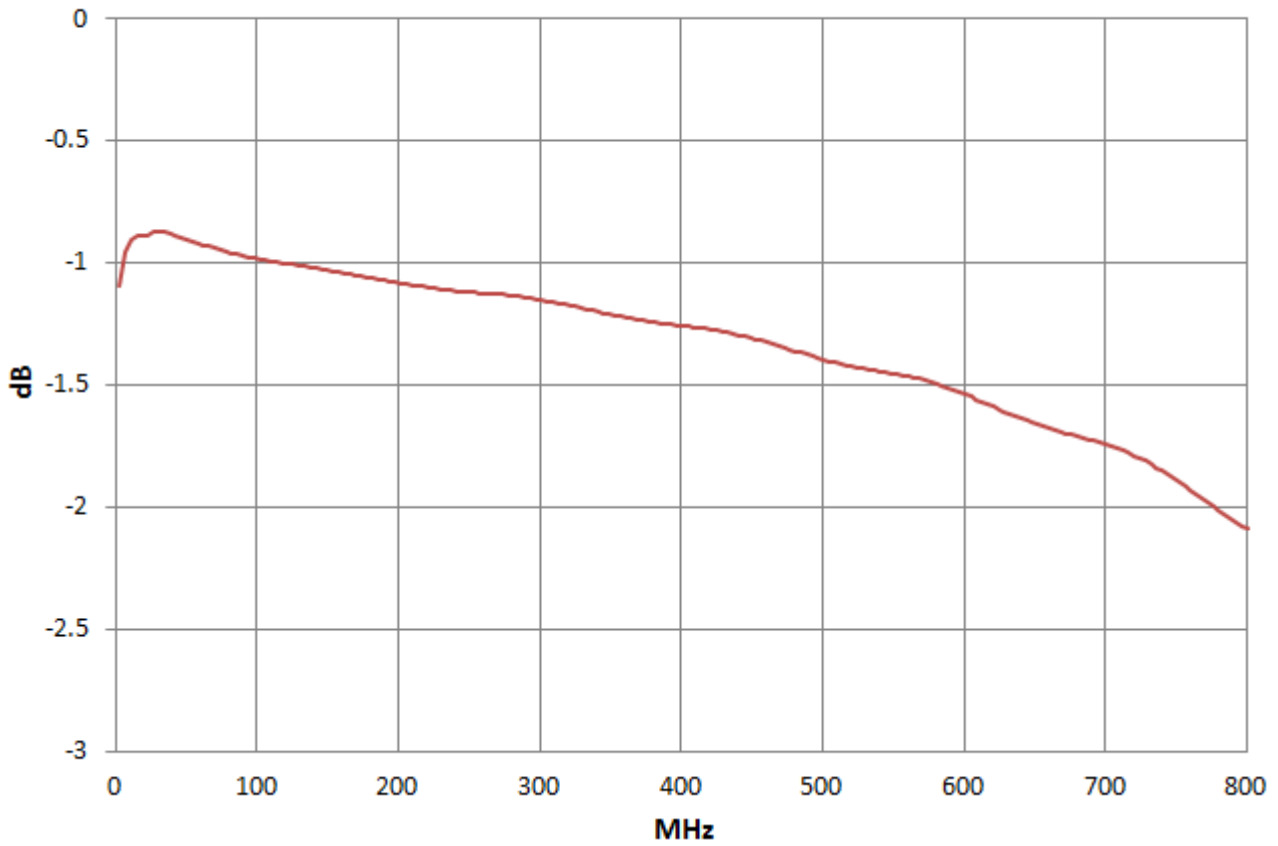

Insertion Loss 6-3

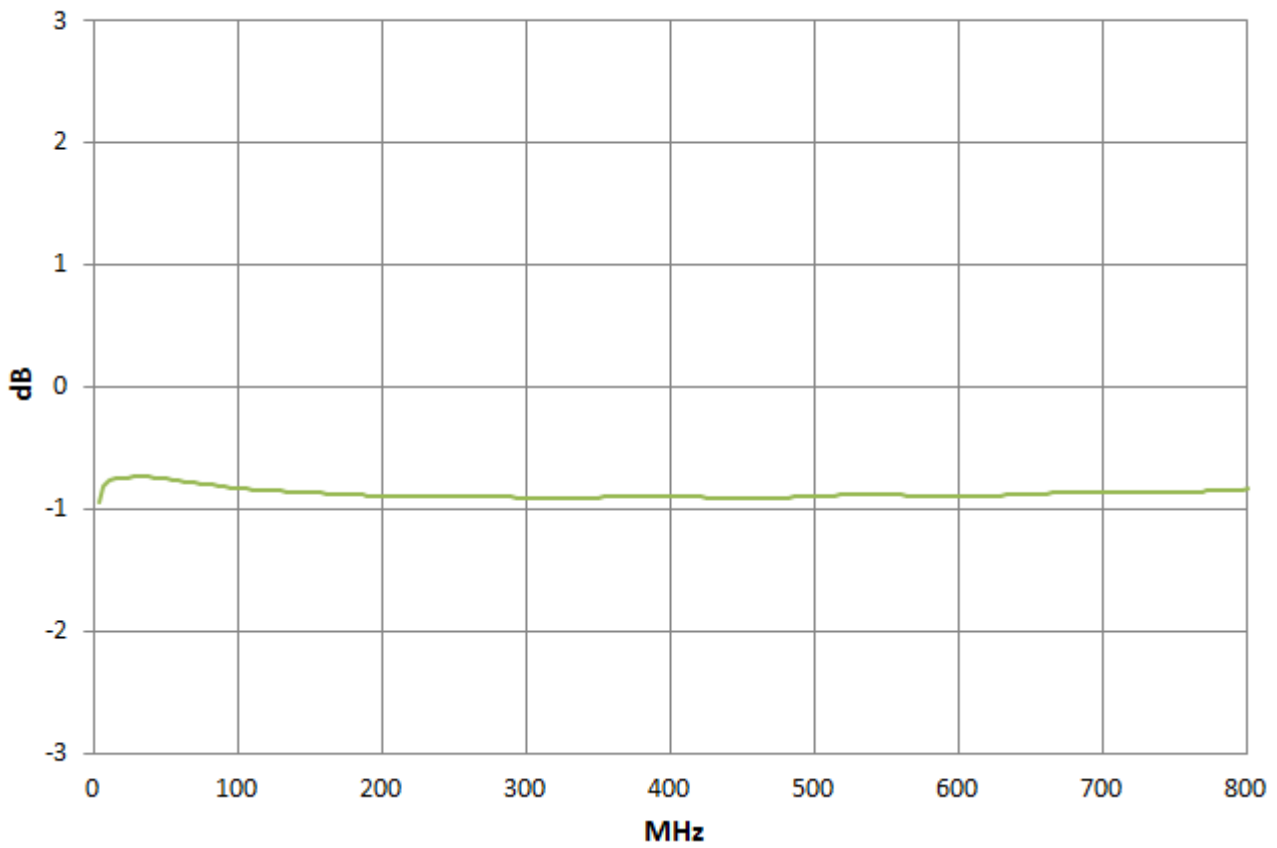

LH Corporation

SL016065 3-800MHZ 1:4 RF flux transformer

Input Return Loss

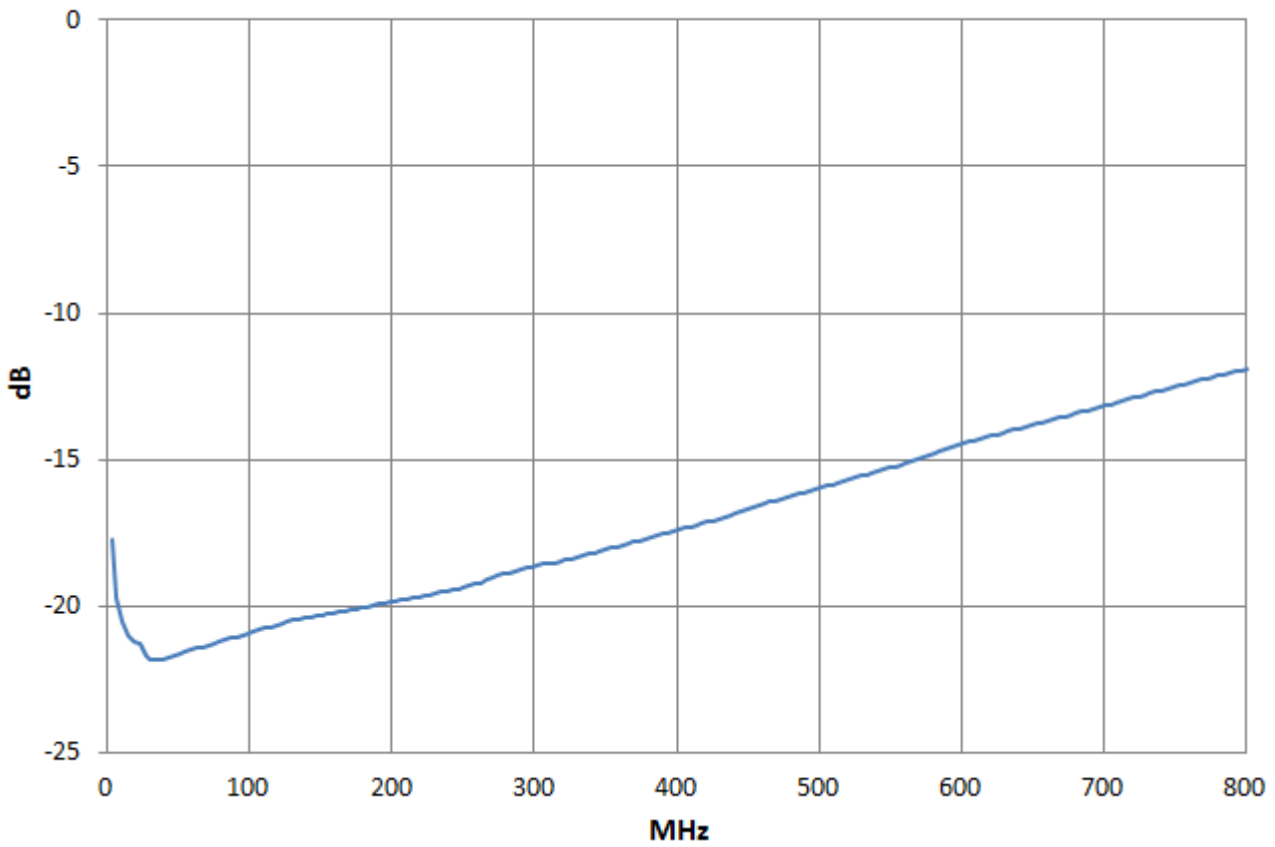

Phase

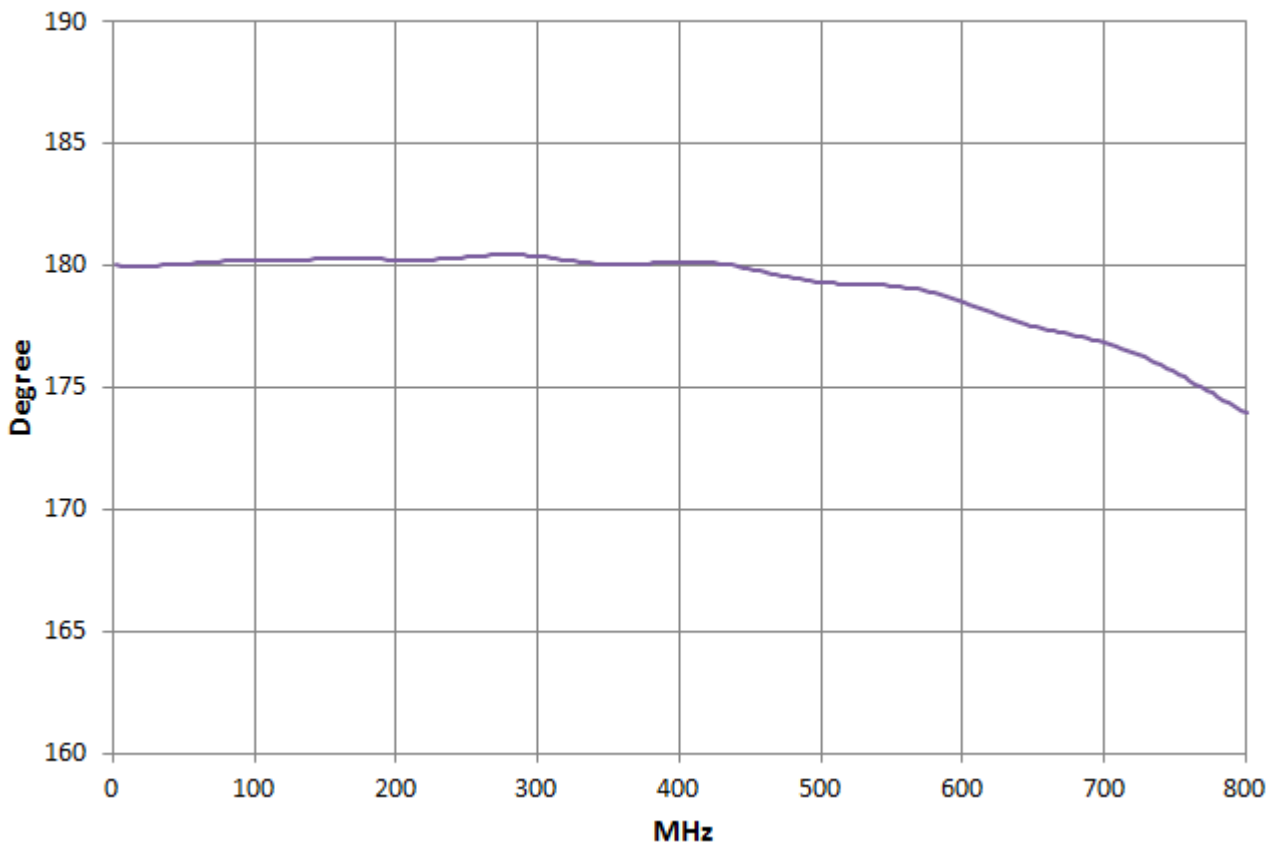

LH Corporation

SL016065 3-800MHZ 1:4 RF flux transformer

Amplitude

