

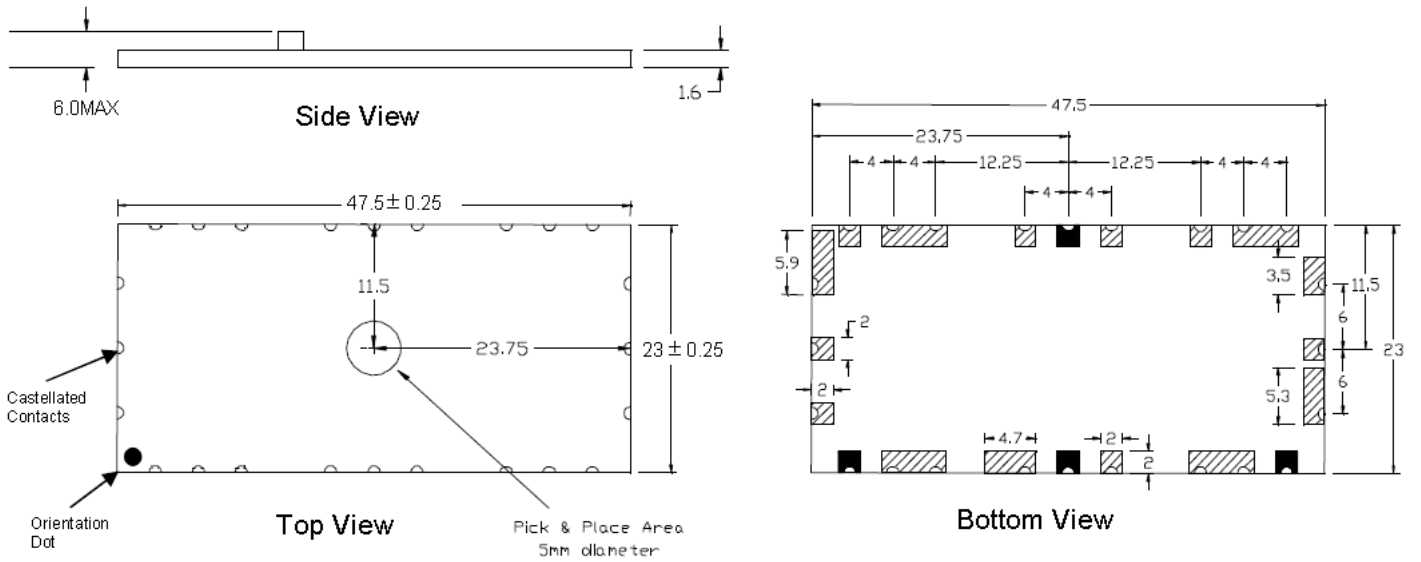

Feature:

- Surface mount
- 260°C reflow compatible
- RoHS\* compliant
- MoCA applications.

Filter Dimensions



Dimensions in mm. Tolerance:  $x \pm 0.1$  unless otherwise noted

Tolerance  $\pm 0.1$  Unit mm

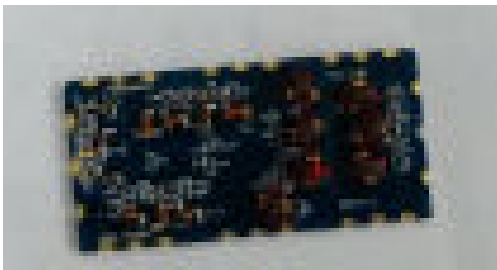

Schematic

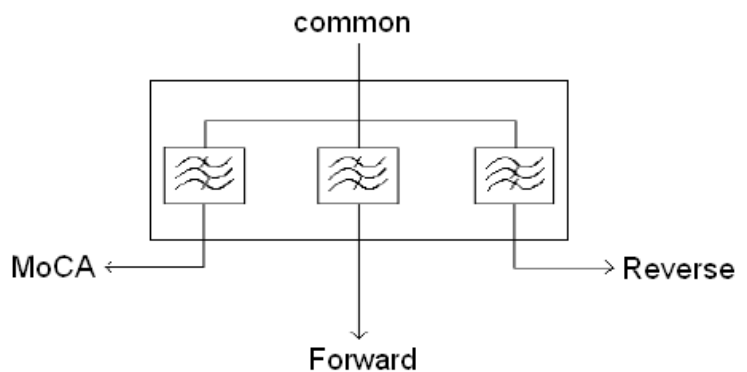

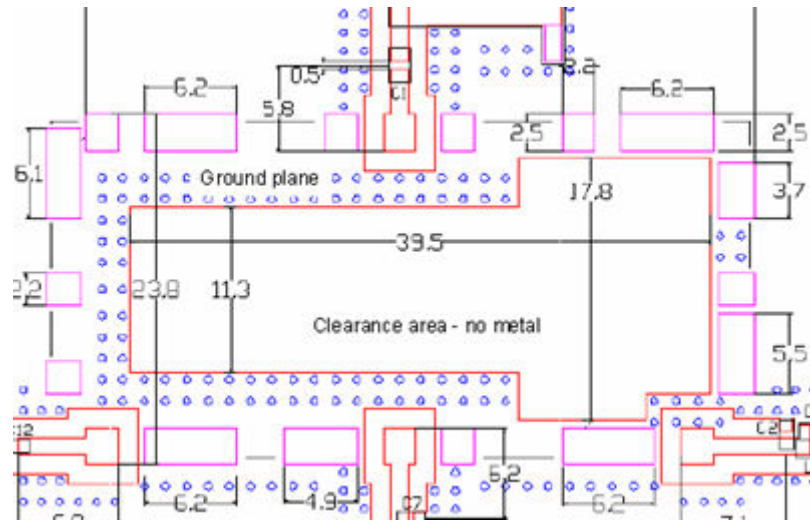

Tolerance  $\pm 0.1$  Unit mm



### PIN CONFIGURATION

PIN	FUNCTION
1	MoCA Port
4	Forward Port
7	Reverse Port
14	Common Port
2,3,5,6	Ground
8,9,10,11	Ground
12,13,15	Ground
16,17,18	Ground
19,20	Ground

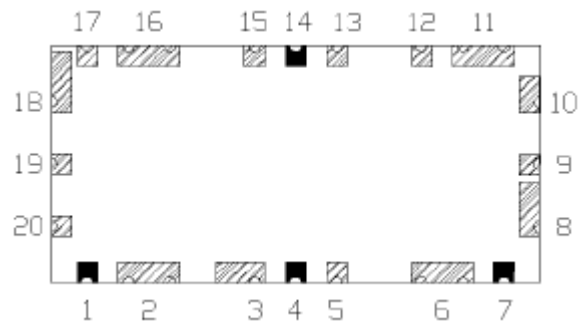



# LH Corporation

## 立华电子

S013184 5-42/54-1002/1125-1675MHZ MoCA Triplex Filter

Electrical Specifications: TA=25°C, Zo=75Ω					
Parameter	Test Conditions	Units	Min.	Typ.	Max.
<b>Insertion Loss (Reverse Path)</b>	5-42MHz	dB	--	1.2	1.5
<b>Rejection</b>	54-88MHz	dB	62	65	--
	88-126MHz	dB	62	65	--
	126-860MHz	dB	64	70	--
	860-1002MHz	dB	64	70	--
	1125-1675MHz	dB	60	64	--
	1675-3000MHz	dB	30	50	--
<b>Insertion Loss (Forward Path)</b>	54-88MHz	dB	--	1.5	2.0
	88-860MHz	dB	--	0.75	1.5
	860-1002MHz	dB	--	2.75	3.0
<b>Rejection</b>	5-38MHz	dB	50	55	--
	38-42MHz	dB	43	45	--
	1125-1675MHz	dB	43	45	--
	1675-3000MHz	dB	20	30	--
<b>Insertion Loss (MoCA Path )</b>	1125-1150MHz	dB	--	2.8	3.0
	1150-1650MHz	dB	--	2.5	2.7
	1650-1675MHz	dB	--	2.5	3.0
<b>Rejection</b>	5-42MHz	dB	49	70	--
	54-1002MHz	dB	49	55	--
	2300-3000MHz	dB	25	35	--
<b>Input Return Loss</b>	5-42MHz	dB	16	18	--
	54-860MHz	dB	16	18	--
	860-1002MHz	dB	12	16	--
	1125-1675MHz	dB	12	16	--
<b>Isolation Forward to Reverse</b>	5-38MHz	dB	55	58	--
	38-42MHz	dB	43	45	--
	54-88MHz	dB	60	65	--
	88-126MHz	dB	60	65	--
	126-860MHz	dB	60	65	--
	860-1002MHz	dB	60	65	--
<b>Isolation Forward to MoCA</b>	5-42MHz	dB	49	70	--
	54-88MHz	dB	49	70	--
	88-126MHz	dB	49	70	--
	126-860MHz	dB	49	53	--
	860-1002MHz	dB	49	55	--
	1125-1150MHz	dB	43	45	--
	1150-1650MHz	dB	43	50	--
	1650-1675MHz	dB	43	50	--
<b>RF Power Rating (max)</b>		250mw			
<b>DC Current Rating (max)</b>		30mA			
<b>Test Impedance (50Ω,75Ω, etc.)</b>		75OHM			
<b>Operating temperature</b>		-40°C to -85°C			
<b>Storage temperature</b>		-40°C to -85°C			



Actual test parameter.

### Common Port Return Loss

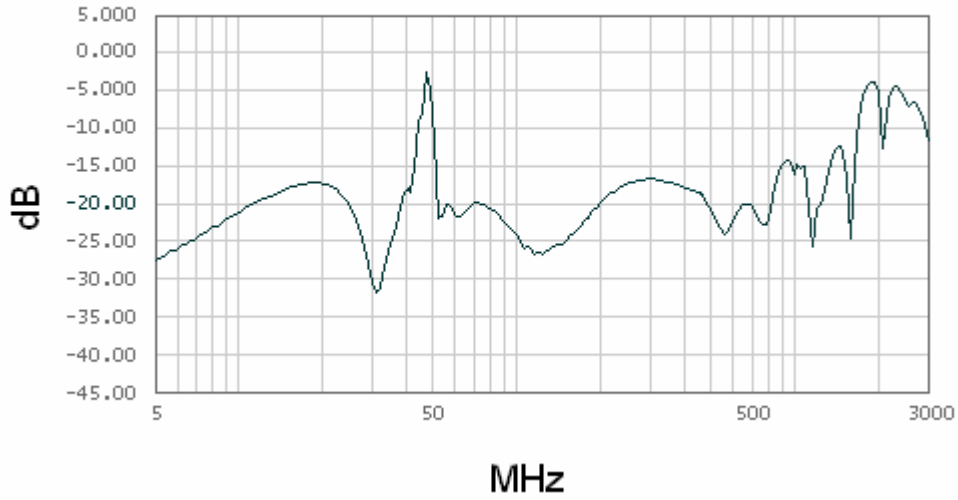

### Reverse Path

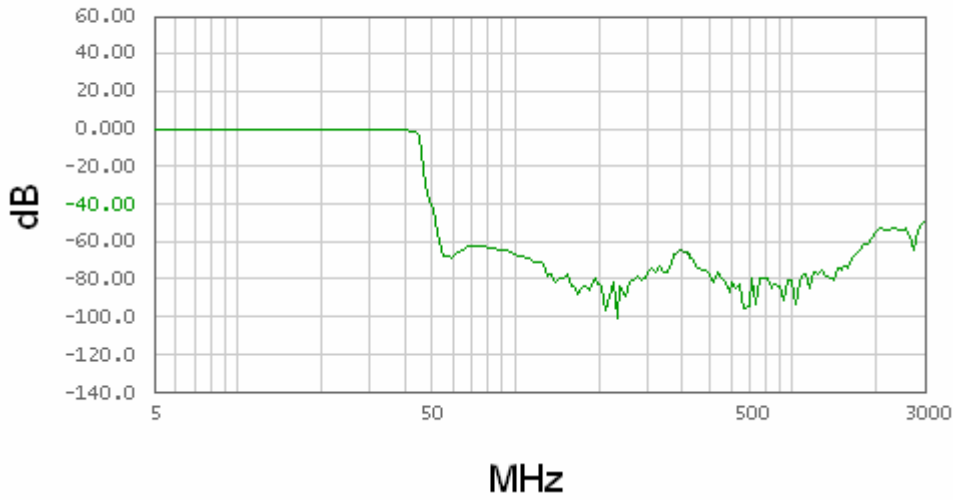

### Forward Path

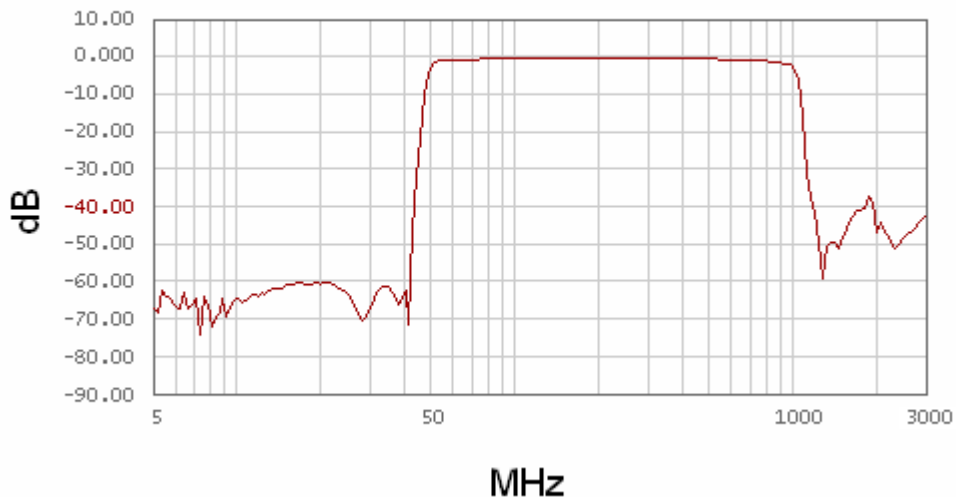



### MoCA Path

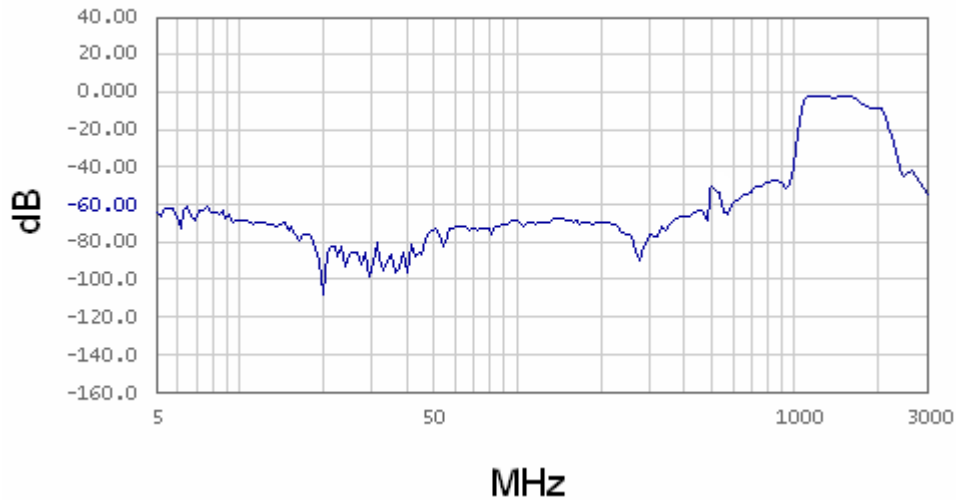

### Reverse to Forward Path Isolation

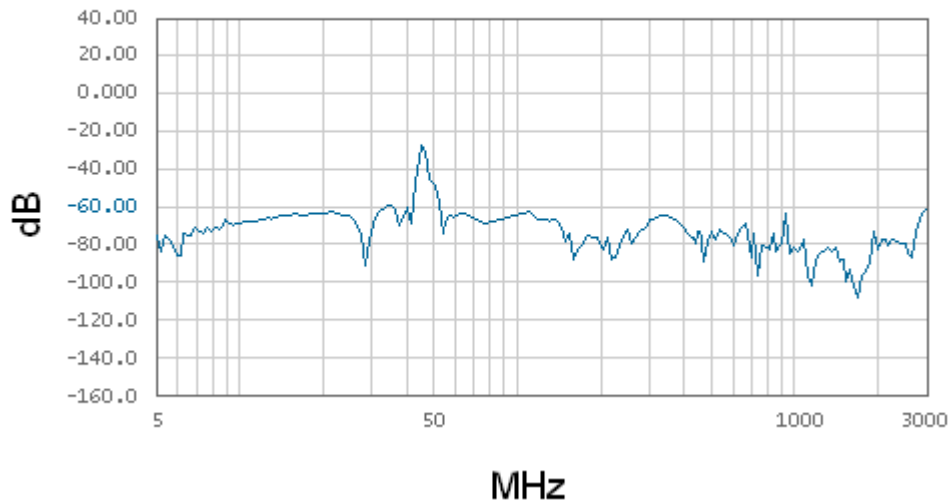

### Forward to MoCA Path Isolation

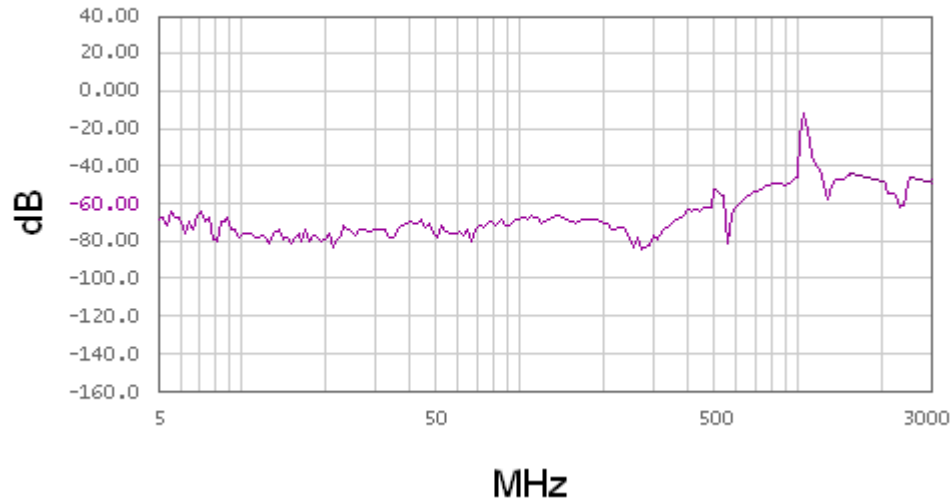



# LH Corporation

## 立华电子

立华电子

S013184 5-42/54-1002/1125-1675MHZ MoCA Triplex Filter

### Tape & Reel

Parameter	Units	Value
Qty per reel	-	200
Reel Size	mm	330
Tape Width	mm	72.0
Pitch	mm	28.0
Ao	mm	23.3
Bo	mm	47.8
Ko	mm	6.8

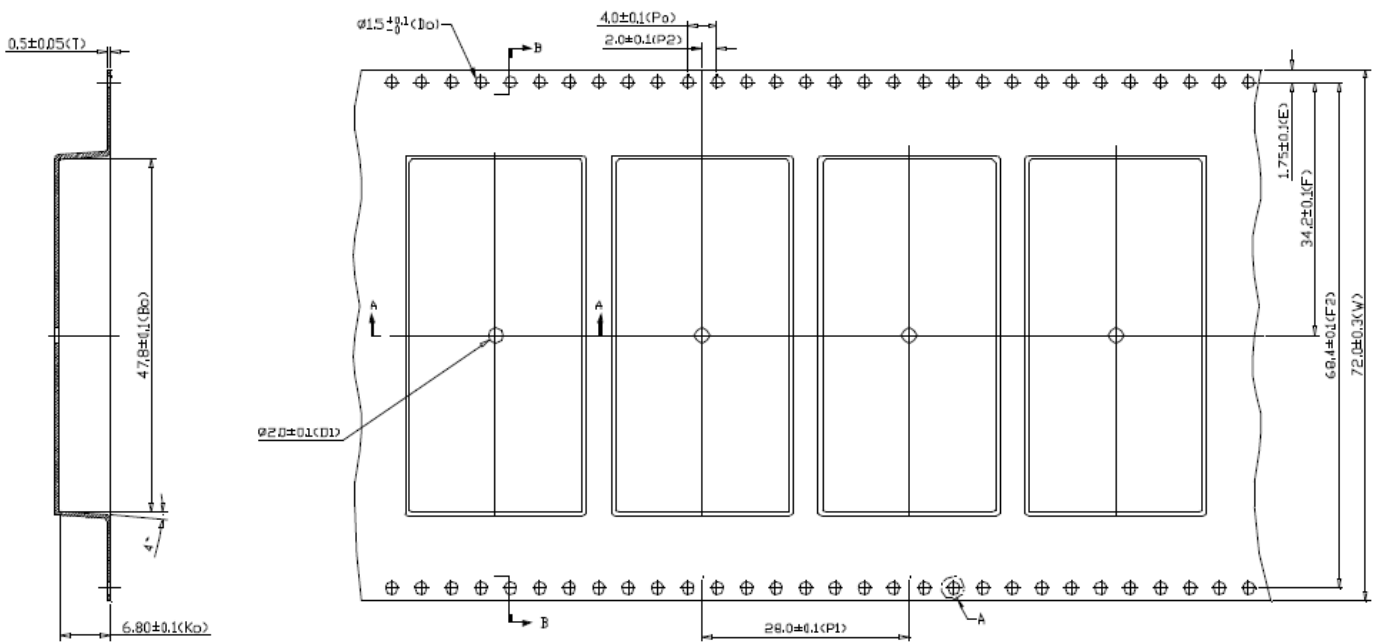

Section B-B



Section A-A

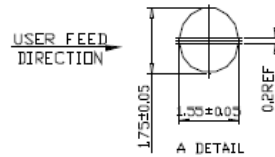

A DETAIL